

<p>MODEL 1404-2279</p> <p>C-TYPE</p>  <p>FITS: 2" DOOR, BOTTOM WEIGHT: 0.3 LBS / FT</p>	<p>MODEL 1404-2280</p> <p>J-TYPE</p>  <p>FITS: 2" DOOR, SIDES & TOP WEIGHT: 0.45 LBS / FT</p>	<p>MODEL 1404-2281</p> <p>J-TYPE</p>  <p>FITS: 2" DOOR, SIDES & TOP WEIGHT: 0.3 LBS / FT</p>
<p>MODEL 1404-2282</p> <p>H-TYPE</p>  <p>FITS: 2" DOOR, SIDES & TOP WEIGHT: 0.45 LBS / FT</p>	<p>MODEL 1404-2283</p> <p>C-TYPE</p>  <p>FITS: 2" DOOR, BOTTOM WEIGHT: 0.4 LBS / FT</p>	<p>MODEL 1404-2284</p> <p>J-TYPE</p>  <p>FITS: 1-1/2" - 2" DOOR, SIDES & TOP WEIGHT: 0.35 LBS / FT</p>
<p>MODEL 1404-2285</p> <p>H-TYPE</p>  <p>FITS: 1-1/2" DOOR, SIDES & TOP WEIGHT: 0.3 LBS / FT</p>	<p>MODEL 1404-2286</p> <p>J-TYPE</p>  <p>FITS: 2" DOOR, SIDES & TOP WEIGHT: 0.4 LBS / FT</p>	<p>MODEL 1404-2287</p> <p>LARGE J-TYPE</p>  <p>FITS: 1-3/4" - 2" DOOR, SIDES & TOP WEIGHT: 0.46 LBS / FT</p>
<p>MODEL 1404-2288</p> <p>C-TYPE</p>  <p>FITS: 1-1/2" - 2" DOOR, BOTTOM WEIGHT: 0.3 LBS / FT</p>	<p>MODEL 1404-2290</p> <p>C-TYPE</p>  <p>FITS: 1-1/2" - 2" DOOR, BOTTOM WEIGHT: 0.35 LBS / FT</p>	<p>MODEL 1404-6247-A</p> <p>NOTE: Sold in 2.5m lengths <u>ONLY</u></p>  <p>FITS: MCIQ REEFER & BUFFERS ASSEMBLIES 1404-6247, 1404-6248 WEIGHT: 0.18 LBS / FT</p>

MODEL 1404-6247-B

NOTE: Sold in 2.5m lengths ONLY

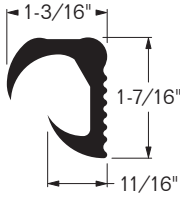
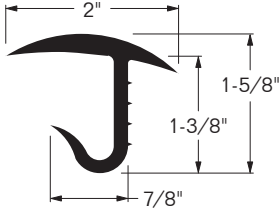
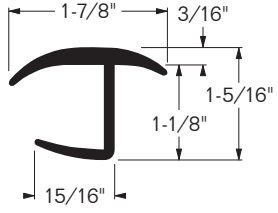
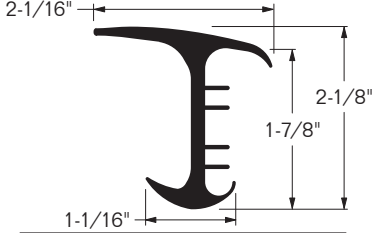
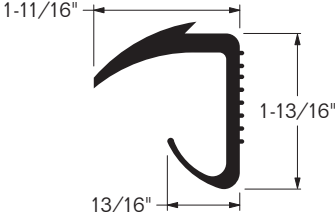
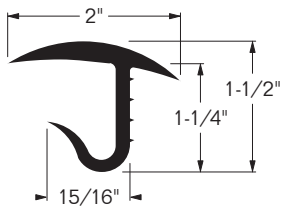
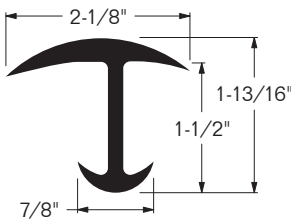
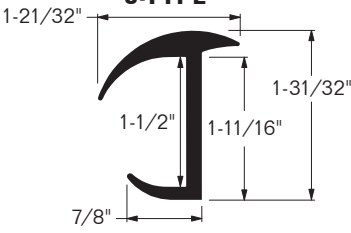
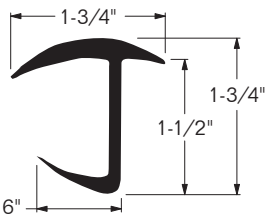
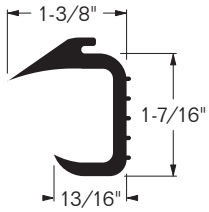
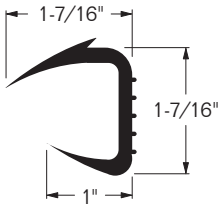
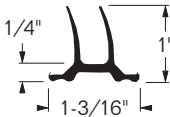
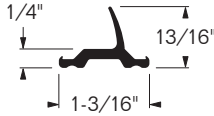

SUB FOR: CIMC 06-006-2
FITS: MCIQ REEFER & BUFFERS ASSEMBLY 1404-6247
WEIGHT: 0.12 LBS / FT

MODEL 1404-6253

BOTTOM OF DOOR, C-TYPE

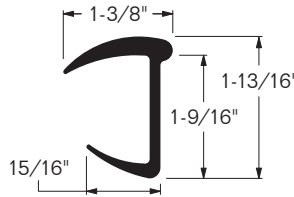

SUB FOR: CIMC D26-02D
FITS: SINGAMAS 53' x 102", J.B. HUNT
WEIGHT: 0.35 LBS / FT

MODEL 1404-6265

J-TYPE

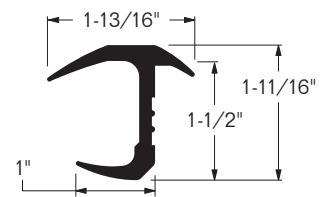

SUB FOR: CIMC D26-03C
FITS: SINGAMAS 53' x 102", J.B. HUNT
WEIGHT: 0.43 LBS / FT

MODEL 1404-6374

NARROW J-TYPE

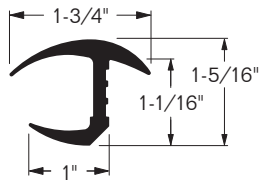

FITS: CIMC
WEIGHT: 0.33 LBS / FT

MODEL 1404-6841-2.5M

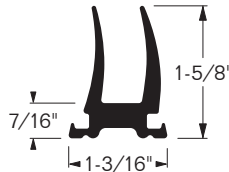

SUB FOR: CIMC 06-005-1, 06-005-2
FITS: CIMC REEFER & BUFFERS ASSEMBLIES 1404-6822-L, 1404-6822-R
LENGTH: 98-1/2" / 2.5 M
WEIGHT: 2.3 LBS / EA.

MODEL 1404-6842-2.5M

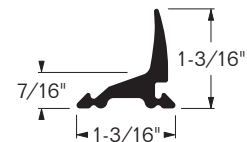

SUB FOR: CIMC 06-005-1
FITS: CIMC REEFER & BUFFERS ASSEMBLY 1404-6822-L
LENGTH: 98-1/2" / 2.5 M
WEIGHT: 1.45 LBS / EA.

MODEL 1404-6843-2.5M

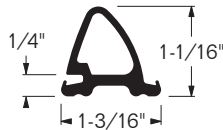

SUB FOR: CIMC 06-003, 06-004
FITS: CIMC REEFER & BUFFERS ASSEMBLIES 1404-6832-L, 1404-6832-R, 1404-6833-L, 1404-6833-R
LENGTH: 98-1/2" / 2.5 M
WEIGHT: 1.65 LBS / EA.

MODEL 1404-6844-2.5M

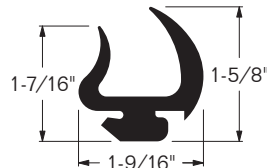

FITS: CIMC REEFER & BUFFERS ASSEMBLIES 1404-6830-L, 1404-6830-R, 1404-6831-L, 1404-6831-R
LENGTH: 98-1/2" / 2.5 M
WEIGHT: 1.31 LBS / EA.

MODEL 1404-6845-2.5M

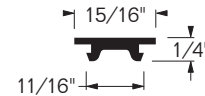

SUB FOR: CIMC 06-002
FITS: CIMC REEFER & BUFFERS ASSEMBLIES 1404-6830-L, 1404-6831-L
LENGTH: 98-1/2" / 2.5 M
WEIGHT: 0.49 LBS / EA.

MODEL 1404-6847-2.5M

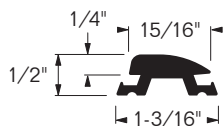

FITS: CIMC REEFER & BUFFERS ASSEMBLIES 1404-6832-L, 1404-6833-L
LENGTH: 98-1/2" / 2.5 M
WEIGHT: 1.48 LBS / EA.

MODEL 1404-7581-2.5M

INNER DOOR GASKET, Hollow

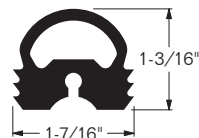

FITS: CIMC & HYUNDAI REEFERS
LENGTH: 98-1/2" / 2.5 M
WEIGHT: 3.92 LBS / 1.78 Kg

MODEL 1404-7585-2.5M

INNER DOOR GASKET, Double Lip

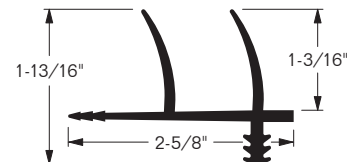

FITS: HYUNDAI REEFER
LENGTH: 98-1/2" / 2.5 M
WEIGHT: 3.08 LBS / 1.4 Kg

MODEL 1404-7919-2.5M

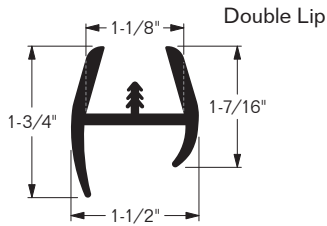

FITS: 1-1/4" PLYMETAL DOORS
LENGTH: 98-1/2" / 2.5 M **COLOR:** GRAY
WEIGHT: 3.15 LBS / 1.43 Kg

MODEL 1404-8953

THRESHOLD GASKET

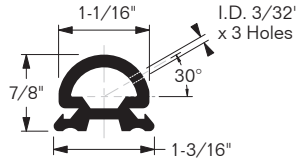

SUB FOR: REEFERCO IN-016
FITS: 40' SINGAMAS REEFER
LENGTH: 90-1/4" / 2,292 MM
COLOR: BLACK **WEIGHT:** 1.54 LBS / 0.7 Kg

MODEL 1404-8954-2.5M

INNER/OUTER DOOR GASKET

for Left & Right Doors

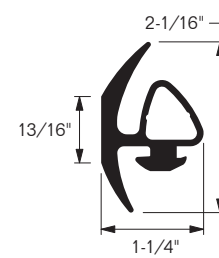

SUB FOR:
CIMC 06-033-L/R,
06-034-L/R,
DA25-A39-EO,
DA25-A42-EO
(Profile A)
FITS:
CIMC REEFER
LENGTH:
98-7/16" / 2.5 M
WEIGHT:
3.4 LBS / 1.5 Kg

MODEL 1404-8954-B-2.5M

DOOR GASKET for Left Door ONLY

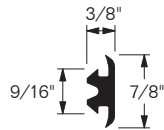

SUB FOR:
CIMC 06-033-L,
06-034-L,
DA25-A39-EO,
DA25-A42-EO
(Profile B)
FITS:
CIMC REEFER
LENGTH:
98-7/16" / 2.5 M
WEIGHT:
0.9 LBS / 0.4 Kg

MODEL 1404-8979-2.5M

INNER/OUTER DOOR GASKET

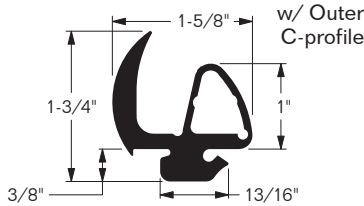

FITS: CIMC REEFER
LENGTH: 98-1/2" / 2.5 M **COLOR:** BLACK
WEIGHT: 5.51 LBS / 2.5 Kg

Models available to fit 1/2" - 1-1/2" Plymetal Doors

MODEL	FITS DOOR THICKNESS	GASKET LENGTH	GASKET WEIGHT
1404-6657-168	1/2" (12.7 MM)	168" / 14'	3.1 LBS / 1.41 Kg
1404-6998-168	3/4" (19 MM)	168" / 14'	3.25 LBS / 1.47 Kg
1404-6999-168	1" (25.4 MM)	168" / 14'	3.4 LBS / 1.54 Kg
1404-7000-168	1-1/4" (31.75 MM)	168" / 14'	4.9 LBS / 2.22 Kg
1404-7001-168	1-1/2" (38.1 MM)	168" / 14'	6.15 LBS / 2.79 Kg

MODEL 1404-6657-168

MODEL 1404-6998-168

MODEL 1404-6999-168

MODEL 1404-7000-168

MODEL 1404-7001-168

DOOR GASKETS

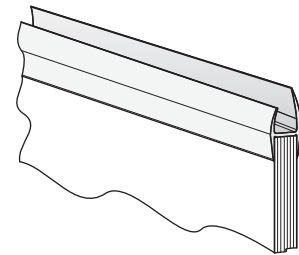

MATERIAL: PVC, DUAL DUROMETER
FINISH: GRAY

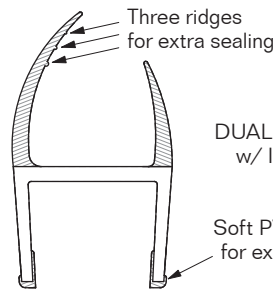

DUAL DUROMETER DESIGN
w/ IMPROVED SEALING

Soft PVC at ends
for extra sealing

MODEL	CORNER TABS FIT	SIZE
1404-7005	OUTSIDE	3/4" x 3" / 19 MM x 76.6 MM
1404-7006	INSIDE	3/4" x 2-9/16" / 19 MM x 65 MM
1404-7007	OUTSIDE (Wide)	1-1/4" x 3-3/16" / 32 MM x 81 MM

MODEL 1404-7005

MODEL 1404-7006

MODEL 1404-7007

CORNER TABS

MODELS 7005 & 7006

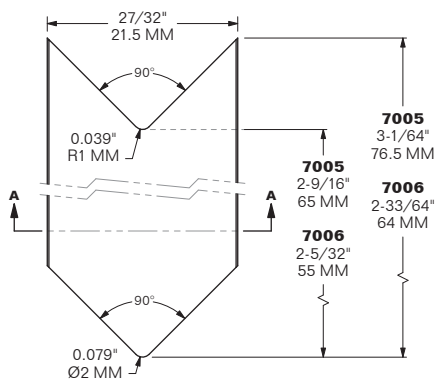

SECTION A-A

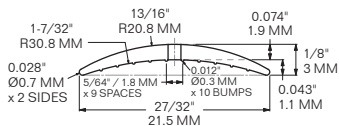

MATERIAL: PVC, DUAL DUROMETER **FINISH:** GRAY

MODEL 7007

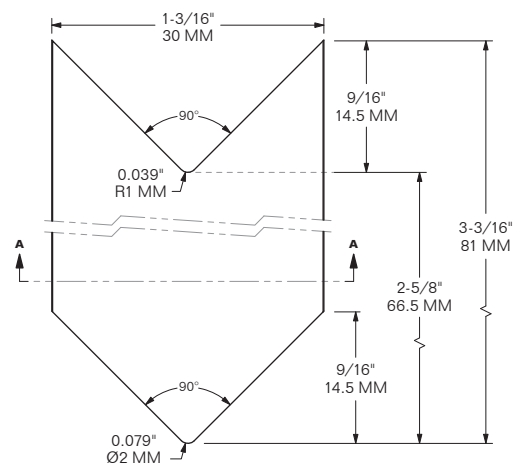

SECTION A-A

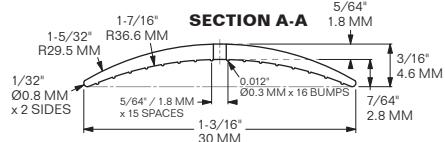



DOOR GASKET ASSEMBLIES

for 8'6" & 9'6" x 96"

ISO CONTAINERS

MODELS 1404-6241 & 1404-6243
3-SIDED DOOR GASKET

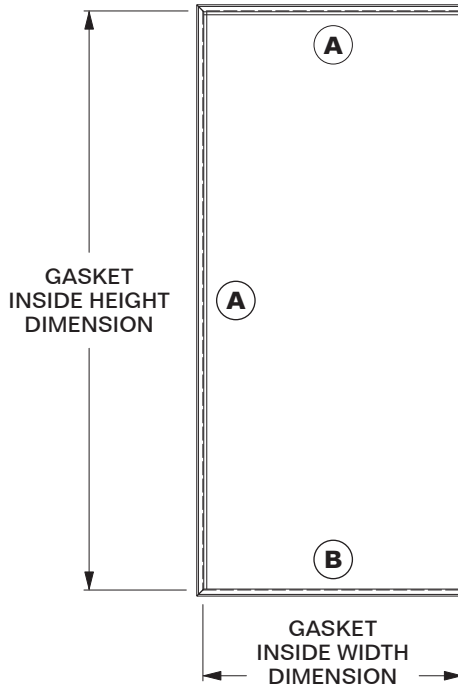

MODELS 1404-6242 & 1404-6244
4-SIDED DOOR GASKET

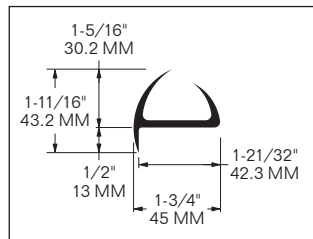
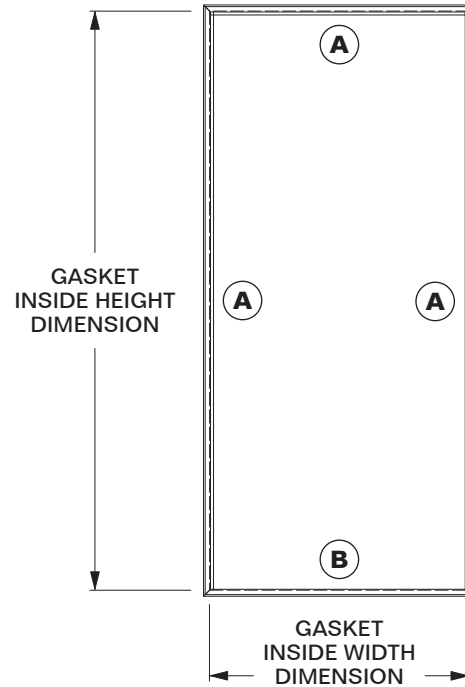

PROFILE **A**

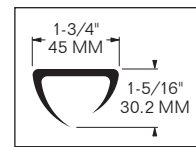

PROFILE **B**

MODEL	DESCRIPTION	GASKET INSIDE WIDTH	GASKET INSIDE HEIGHT	WEIGHT
MODEL 1404-6241	3-SIDED FOR 9' 6" CONTAINER	44" FOR 45" WIDTH DOOR	99" FOR 101" HEIGHT DOOR	5 LBS 2.27 Kg
MODEL 1404-6242	4-SIDED FOR 9' 6" CONTAINER	44" FOR 45" WIDTH DOOR	99" FOR 101" HEIGHT DOOR	7.75 LBS 3.52 Kg
MODEL 1404-6243	3-SIDED FOR 8' 6" CONTAINER	44" FOR 45" WIDTH DOOR	87" FOR 88.6" HEIGHT DOOR	5.7 LBS 2.59 Kg
MODEL 1404-6244	4-SIDED FOR 8' 6" CONTAINER	44" FOR 45" WIDTH DOOR	87" FOR 88.6" HEIGHT DOOR	7.95 LBS 3.61 Kg

BUFFERS USA INC

"The Intermodal Hardware Specialists"

1404-5



904-696-0010

E-mail: sales@buffersusa.com



DOOR GASKET ASSEMBLIES

for 48' & 53' x 102" CONTAINERS w/
107" & 110" DOOR HEIGHT OPENING
DOMCON CONTAINERS

MODELS 1404-6251 & 1404-6261
3-SIDED DOOR GASKET

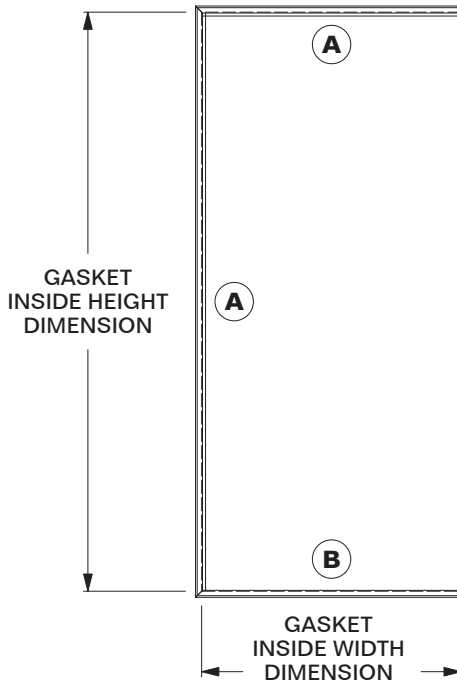

MODELS 1404-6252 & 1404-6262
4-SIDED DOOR GASKET

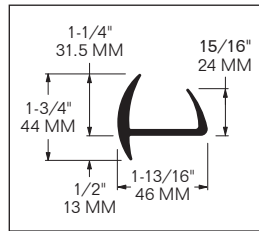
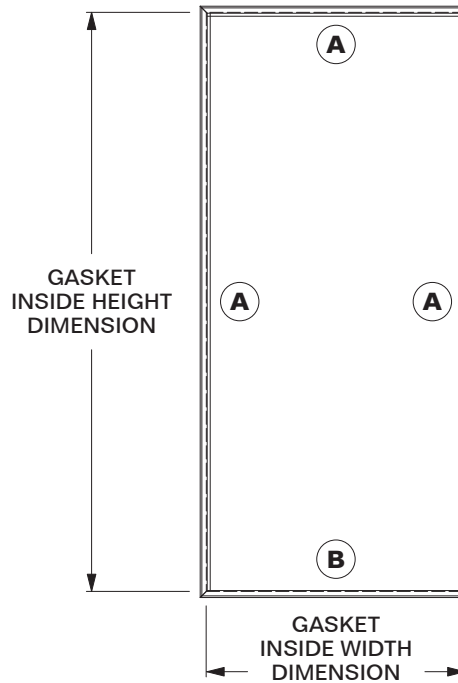

PROFILE **A**

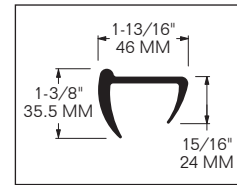

PROFILE **B**

MODELS 1404-6251 & 1404-6252 FIT: CSX 48' x 107" H, PACER 48', 53' x 107" H
MODELS 1404-6261 & 1404-6262 FIT: J.B. HUNT, CSX, PACER 53' x 110" H

MODEL	DESCRIPTION	GASKET INSIDE WIDTH	GASKET INSIDE HEIGHT	WEIGHT
MODEL 1404-6251	3-SIDED FOR 107" DOOR OPENING	47-1/4"	104"	7.05 LBS 3.2 Kg
MODEL 1404-6252	4-SIDED FOR 107" DOOR OPENING	47-7/16"	104"	10.65 LBS 4.83 Kg
MODEL 1404-6261	3-SIDED FOR 110" DOOR OPENING	47-1/4"	106-11/16"	7.3 LBS 3.31 Kg
MODEL 1404-6262	4-SIDED FOR 110" DOOR OPENING	47-7/16"	106-11/16"	11.5 LBS 5.22 Kg





DOOR GASKET ASSEMBLIES

for 45' x 102" CONTAINERS w/
110" DOOR HEIGHT OPENING
DOMCON CONTAINERS

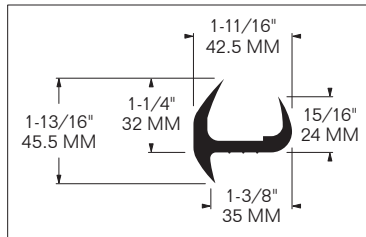
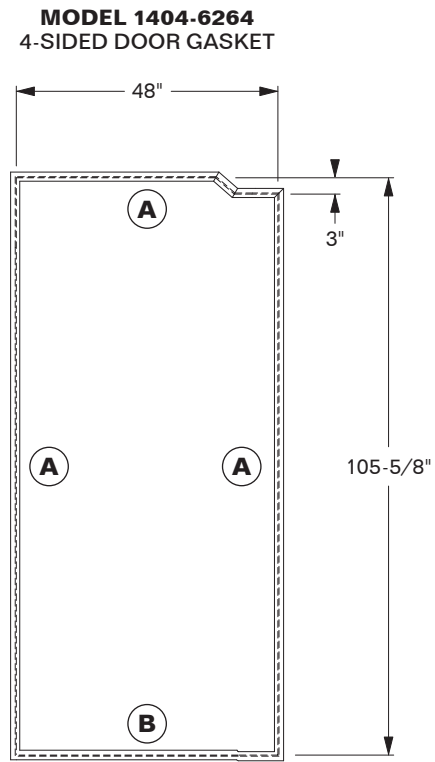
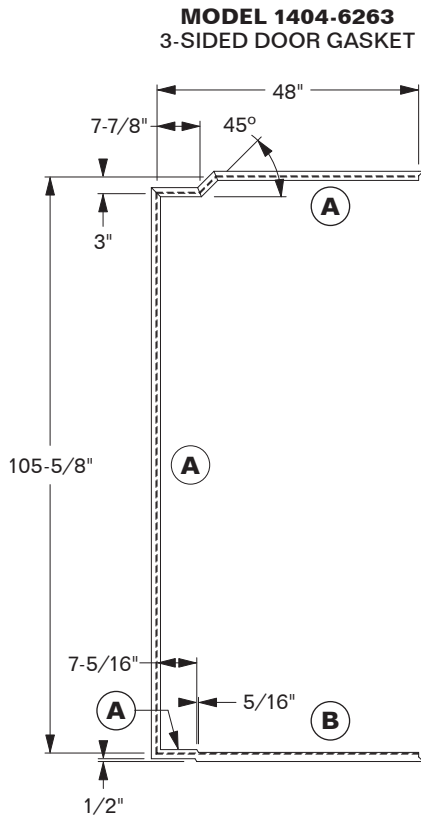

PROFILE **A**

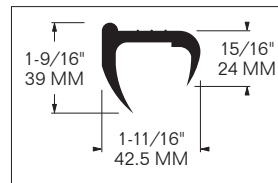

PROFILE **B**

MODELS 1404-6263 & 1404-6264 FIT: CROWLEY 45' x 102" w/ 110" Door Opening

MODEL	DESCRIPTION	GASKET INSIDE WIDTH	GASKET INSIDE HEIGHT	WEIGHT
MODEL 1404-6263	3-SIDED FOR 110" DOOR OPENING	48"	105-5/8"	7 LBS 3.18 Kg
MODEL 1404-6264	4-SIDED FOR 110" DOOR OPENING	48"	105-5/8"	10.45 LBS 4.74 Kg

BUFFERS USA INC

"The Intermodal Hardware Specialists"

1404-7



904-696-0010

E-mail: sales@buffersusa.com



DOOR GASKET ASSEMBLIES

for 9'6" x 96"
REEFER CONTAINERS

MODEL 1404-6247
THERMAL DOOR GASKET
INNER, LEFT

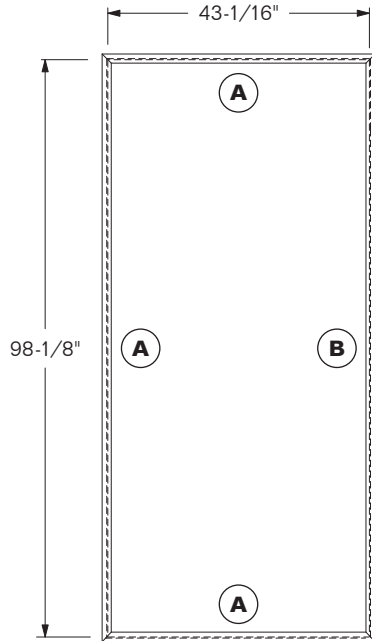

MODEL 1404-6248
THERMAL DOOR GASKET
INNER, RIGHT

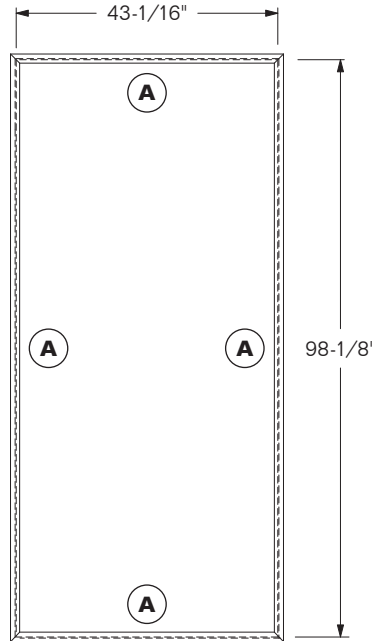

MODEL 1404-6247-A

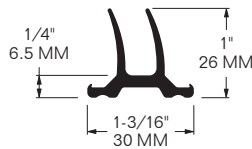

PROFILE **A**

MODEL 1404-6247-B

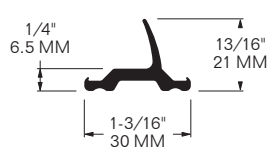

PROFILE **B**

MODELS 1404-6247 & 1404-6248 FIT: MAERSK MCIQ 40'

MODEL	DESCRIPTION	GASKET INSIDE WIDTH	GASKET INSIDE HEIGHT	WEIGHT
MODEL 1404-6247	4-SIDED THERMAL DOOR GASKET (LEFT) SUB FOR: MAERSK 7813629	43-1/16"	98-1/8"	3.6 LBS 1.6 Kg
MODEL 1404-6248	4-SIDED THERMAL DOOR GASKET (RIGHT) SUB FOR: MAERSK 7813478	43-1/16"	98-1/8"	4 LBS 1.8 Kg

BUFFERS USA INC

"The Intermodal Hardware Specialists"

1404-8



904-696-0010

E-mail: sales@buffersusa.com



DOOR GASKET ASSEMBLIES

for 8'6" & 9'6" x 96" CIMC

REEFER CONTAINERS

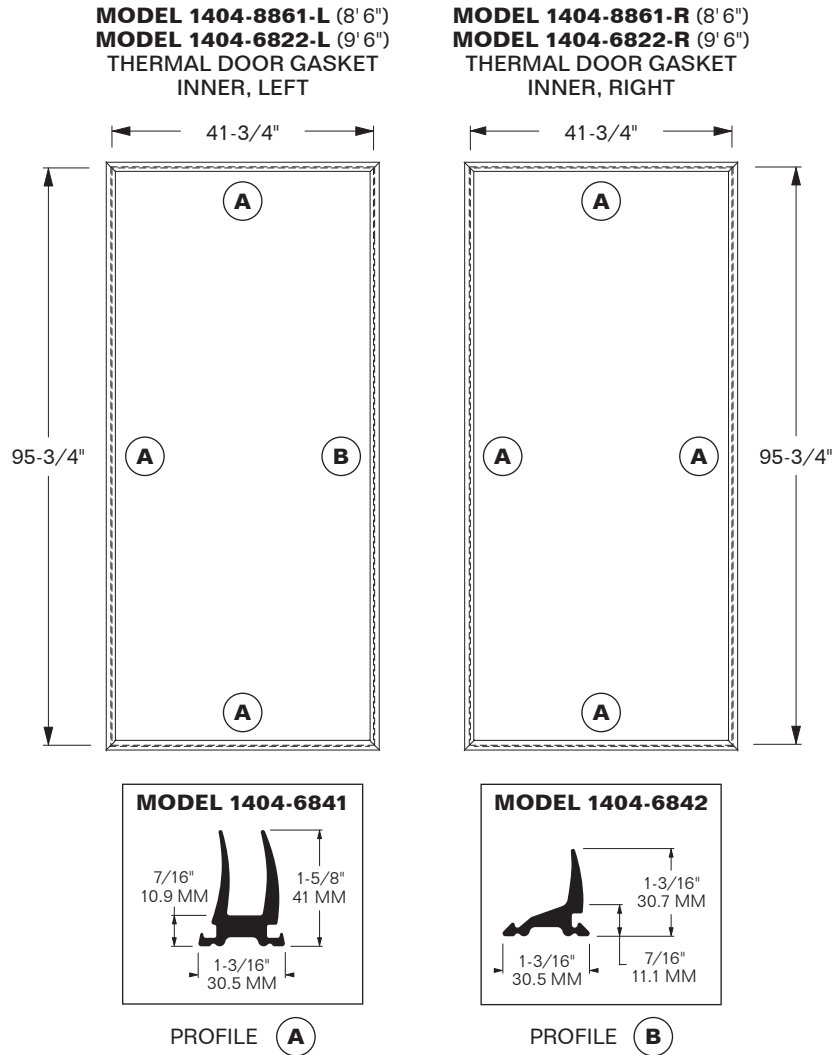

MODEL	DESCRIPTION	GASKET INSIDE WIDTH	GASKET INSIDE HEIGHT	WEIGHT
MODEL 1404-8861-L FOR 8'6" HEIGHT CONTAINERS	4-SIDED THERMAL DOOR GASKET (LEFT) SUB FOR: CIMC	42" (1,066 MM) for 42-7/8" (1,088 MM) DOOR	84-3/4" (2,150 MM) for 87-7/16" (2,220 MM) DOOR	6.85 LBS 3.1 Kg
MODEL 1404-8861-R FOR 8'6" HEIGHT CONTAINERS	4-SIDED THERMAL DOOR GASKET (RIGHT) SUB FOR: CIMC	42" (1,066 MM) for 42-7/8" (1,088 MM) DOOR	84-3/4" (2,150 MM) for 87-7/16" (2,220 MM) DOOR	7.05 LBS 3.2 Kg
MODEL 1404-6822-L FOR 9'6" HEIGHT CONTAINERS	4-SIDED THERMAL DOOR GASKET (LEFT) SUB FOR: CIMC 06-005-L	41-3/4" (1,060 MM) for 43-5/8" (1,108 MM) DOOR	95-3/4" (2,430 MM) for 99-7/16" (2,526 MM) DOOR	7.3 LBS 3.3 Kg
MODEL 1404-6822-R FOR 9'6" HEIGHT CONTAINERS	4-SIDED THERMAL DOOR GASKET (RIGHT) SUB FOR: CIMC 06-005-R	41-3/4" (1,060 MM) for 43-5/8" (1,108 MM) DOOR	95-3/4" (2,430 MM) for 99-7/16" (2,526 MM) DOOR	7.65 LBS 3.47 Kg

BUFFERS USA INC

"The Intermodal Hardware Specialists"

1404-9



904-696-0010

E-mail: sales@buffersusa.com



DOOR GASKET ASSEMBLIES

for 8'6" & 9'6" x 96"
REEFER CONTAINERS

MODEL 1404-6830-L (8' 6")
MODEL 1404-6831-L (9' 6")
DOOR GASKET, INNER, LEFT

MODEL 1404-6830-R (8' 6")
MODEL 1404-6831-R (9' 6")
DOOR GASKET, INNER, RIGHT

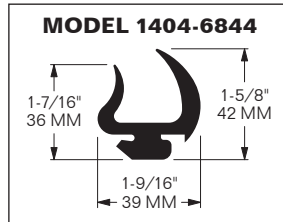
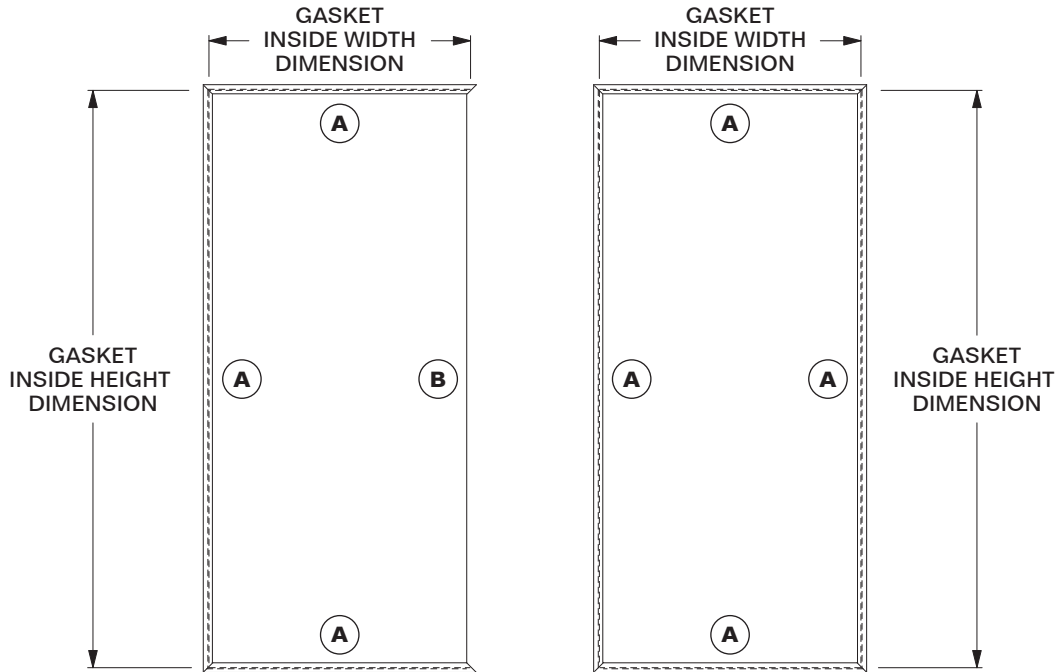

PROFILE **A**

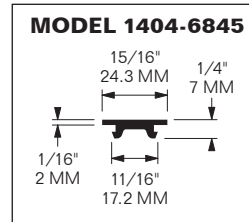

PROFILE **B**

MODELS 1404-6830 & 1404-6831 FIT: CIMC 40' REEFER

MODEL	DESCRIPTION	GASKET INSIDE WIDTH	GASKET INSIDE HEIGHT	WEIGHT
MODEL 1404-6830-L FOR 8'6" HEIGHT CONTAINERS	4-SIDED THERMAL DOOR GASKET (LEFT) SUB FOR: CIMC 06-002-L	43-1/8" (1,095 MM) for 44" (1,117 MM) DOOR	85" (2,160 MM) for 87-11/16" (2,227 MM) DOOR	7.15 LBS 3.24 Kg
MODEL 1404-6830-R FOR 8'6" HEIGHT CONTAINERS	4-SIDED THERMAL DOOR GASKET (RIGHT) SUB FOR: CIMC 06-002-R	43-1/8" (1,095 MM) for 44" (1,117 MM) DOOR	85" (2,160 MM) for 87-11/16" (2,227 MM) DOOR	8.65 LBS 3.92 Kg
MODEL 1404-6831-L FOR 9'6" HEIGHT CONTAINERS	4-SIDED THERMAL DOOR GASKET (LEFT) SUB FOR: CIMC 06-001-L	43-1/8" (1,095 MM) for 44" (1,117 MM) DOOR	96-5/8" (2,455 MM) for 99-5/8" (2,532 MM) DOOR	7.6 LBS 3.45 Kg
MODEL 1404-6831-R FOR 9'6" HEIGHT CONTAINERS	4-SIDED THERMAL DOOR GASKET (RIGHT) SUB FOR: CIMC 06-001-R	43-1/8" (1,095 MM) for 44" (1,117 MM) DOOR	96-5/8" (2,455 MM) for 99-5/8" (2,532 MM) DOOR	9.45 LBS 4.29 Kg

BUFFERS USA INC

"The Intermodal Hardware Specialists"

1404-10



904-696-0010

E-mail: sales@buffersusa.com



DOOR GASKET ASSEMBLIES

for 8'6" & 9'6" x 96"
REEFER CONTAINERS

MODEL 1404-6832-L (8' 6")
MODEL 1404-6833-L (9' 6")
DOOR GASKET, INNER, LEFT

MODEL 1404-6832-R (8' 6")
MODEL 1404-6833-R (9' 6")
DOOR GASKET, INNER, RIGHT

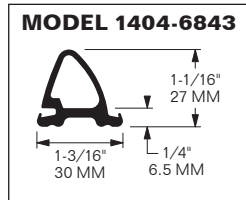
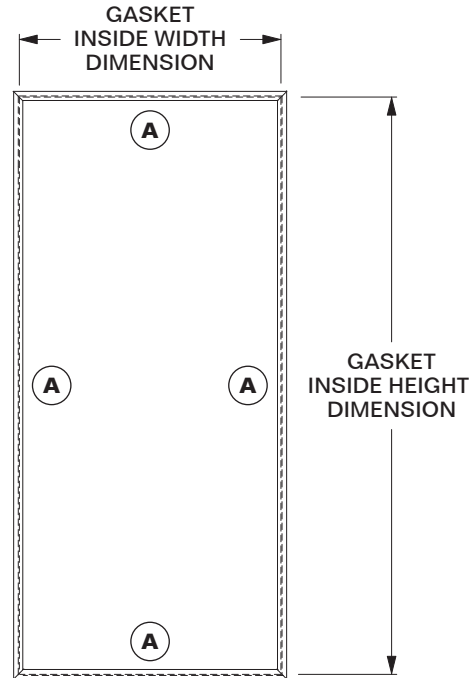
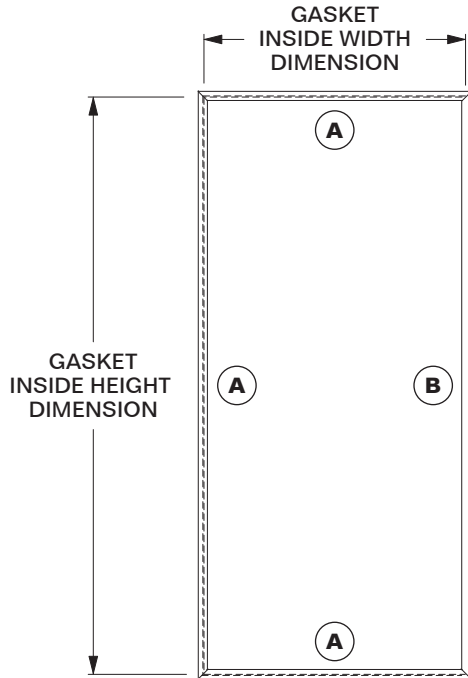

PROFILE **A**

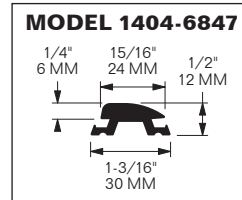

PROFILE **B**

MODELS 1404-6832 & 1404-6833 FIT: CIMC 40' REEFER

MODEL	DESCRIPTION	GASKET INSIDE WIDTH	GASKET INSIDE HEIGHT	WEIGHT
MODEL 1404-6832-L FOR 8'6" HEIGHT CONTAINERS	4-SIDED THERMAL DOOR GASKET (LEFT) SUB FOR: CIMC 06-004-L	41-3/4" (1,060 MM) for 43-5/8" (1,108 MM) DOOR	81-5/16" (2,065 MM) for 87-7/16" (2,220 MM) DOOR	3.65 LBS 1.65 Kg
MODEL 1404-6832-R FOR 8'6" HEIGHT CONTAINERS	4-SIDED THERMAL DOOR GASKET (RIGHT) SUB FOR: CIMC 06-004-R	41-3/4" (1,060 MM) for 43-5/8" (1,108 MM) DOOR	81-5/16" (2,065 MM) for 87-7/16" (2,220 MM) DOOR	3.85 LBS 1.75 Kg
MODEL 1404-6833-L FOR 9'6" HEIGHT CONTAINERS	4-SIDED THERMAL DOOR GASKET (LEFT) SUB FOR: CIMC 06-003-L	41-3/4" (1,060 MM) for 43-5/8" (1,108 MM) DOOR	92-15/16" (2,360 MM) for 99-7/16" (2,526 MM) DOOR	3.8 LBS 1.72 Kg
MODEL 1404-6833-R FOR 9'6" HEIGHT CONTAINERS	4-SIDED THERMAL DOOR GASKET (RIGHT) SUB FOR: CIMC 06-003-R	41-3/4" (1,060 MM) for 43-5/8" (1,108 MM) DOOR	92-15/16" (2,360 MM) for 99-7/16" (2,526 MM) DOOR	4.05 LBS 1.84 Kg

BUFFERS USA INC

"The Intermodal Hardware Specialists"

1404-11



904-696-0010

E-mail: sales@buffersusa.com



DOOR GASKET ASSEMBLIES

for 8'6" & 9'6" x 96"
REEFER CONTAINERS

MODEL 1404-8954-L (8'6")
MODEL 1404-8955-L (9'6")
DOOR GASKET, Combo Design Inner & Outer, Left

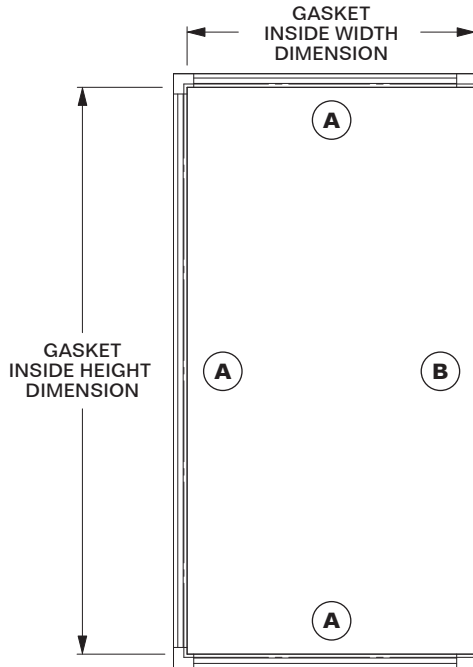

MODEL 1404-8954-R (8'6")
MODEL 1404-8955-R (9'6")
DOOR GASKET, Combo Design Inner & Outer, Right

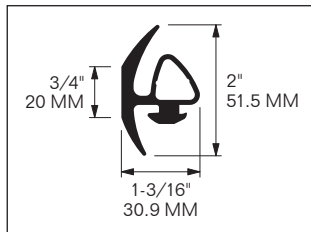
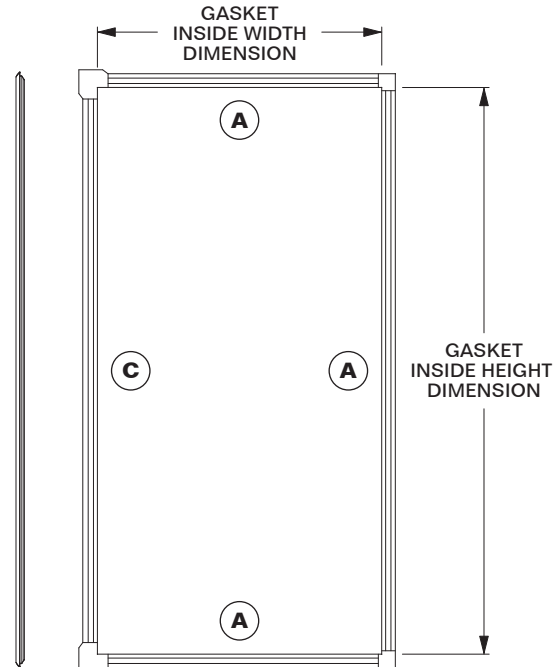

PROFILE **A**

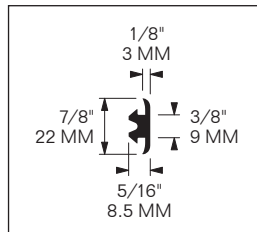

PROFILE **B**

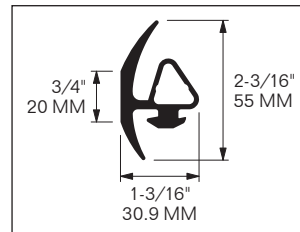

PROFILE **C**

MODELS 1404-8954-L/R & 1404-8955-L/R FIT: CIMC 40' REEFER

MODEL	DESCRIPTION	GASKET INSIDE WIDTH	GASKET INSIDE HEIGHT	WEIGHT
MODEL 1404-8954-L FOR 8'6" HEIGHT CONTAINERS	4-SIDED THERMAL DOOR GASKET (LEFT) w/ flat center gasket SUB FOR: CIMC 06-033-L	43-1/8" / 1,095.4 MM	85" / 2,159 MM	6.68 LBS 3 Kg
MODEL 1404-8954-R FOR 8'6" HEIGHT CONTAINERS	4-SIDED THERMAL DOOR GASKET (RIGHT) SUB FOR: CIMC 06-033-R	43-1/8" / 1,095.4 MM	85" / 2,159 MM	9 LBS 4.1 Kg
MODEL 1404-8955-L FOR 9'6" HEIGHT CONTAINERS	4-SIDED THERMAL DOOR GASKET (LEFT) SUB FOR: CIMC 06-034-L	43-1/8" / 1,095.4 MM	96-5/8" / 2,454.3 MM	7.4 LBS 3.4 Kg
MODEL 1404-8955-R FOR 9'6" HEIGHT CONTAINERS	4-SIDED THERMAL DOOR GASKET (RIGHT) SUB FOR: CIMC 06-034-R	43-1/8" / 1,095.4 MM	96-5/8" / 2,454.3 MM	10 LBS 4.5 Kg

BUFFERS USA INC

"The Intermodal Hardware Specialists"

1404-12



904-696-0010

E-mail: sales@buffersusa.com

MODEL 1404-6933
3-SIDED OUTER DOOR GASKET

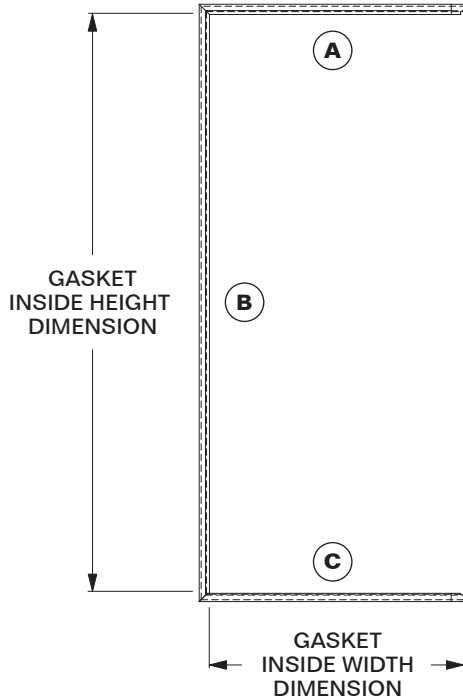

MODEL 1404-6934
4-SIDED OUTER DOOR GASKET

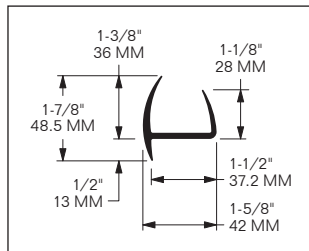
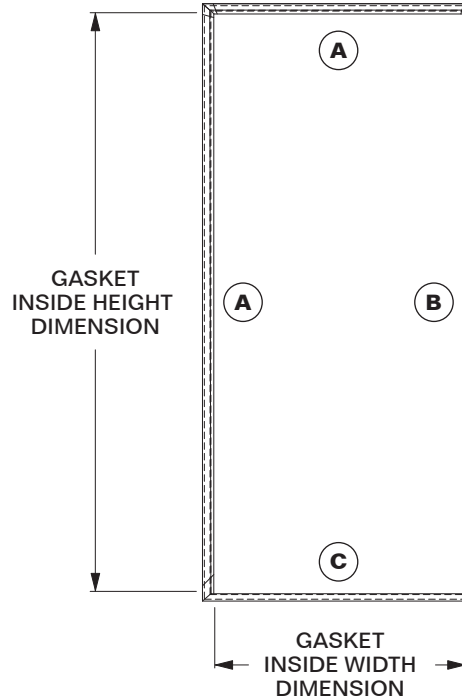

PROFILE **(A)**

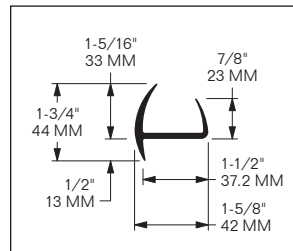

PROFILE **(B)**

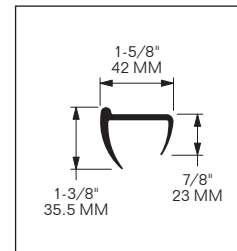

PROFILE **(C)**

MODELS 1404-6933 & 1404-6934
SUB FOR: MAERSK 7813100 FIT: 40' MCIQ REEFER

MODEL	DESCRIPTION	GASKET INSIDE WIDTH	GASKET INSIDE HEIGHT	WEIGHT
MODEL 1404-6933	3-SIDED FOR 9' 6" CONTAINER	44" FOR 45" WIDTH DOOR	99" FOR 101" HEIGHT DOOR	5.8 LBS 2.6 Kg
MODEL 1404-6934	4-SIDED FOR 9' 6" CONTAINER	44" FOR 45" WIDTH DOOR	99" FOR 101" HEIGHT DOOR	9.3 LBS 4.2 Kg

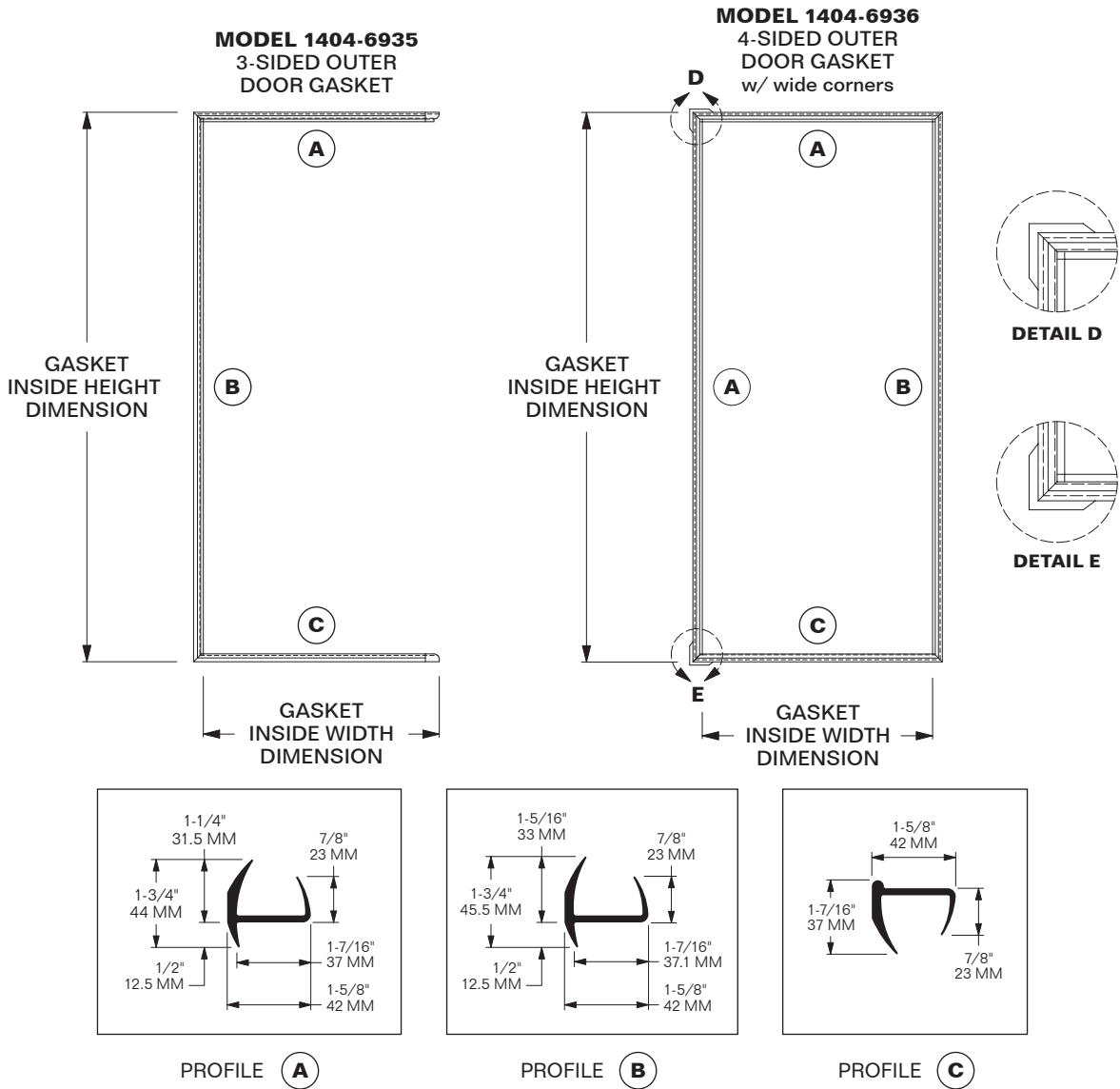

MODELS 1404-6935 & 1404-6936
SUB FOR: MAERSK 7813151 FIT: 40' MCIQ REEFER

MODEL	DESCRIPTION	GASKET INSIDE WIDTH	GASKET INSIDE HEIGHT	WEIGHT
MODEL 1404-6935	3-SIDED FOR 9'6" CONTAINER	44" FOR 45" WIDTH DOOR	99" FOR 101" HEIGHT DOOR	5.5 LBS 2.5 Kg
MODEL 1404-6936	4-SIDED FOR 9'6" CONTAINER w/ wide corners	44" FOR 45" WIDTH DOOR	99" FOR 101" HEIGHT DOOR	8.2 LBS 3.7 Kg

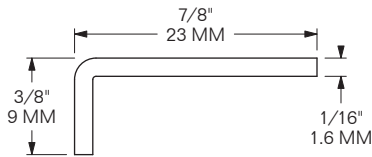

MODELS 1404-6392 - 1404-6395

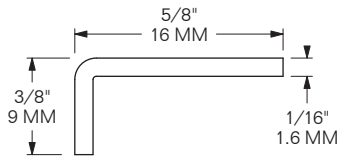

MODEL 1404-6396

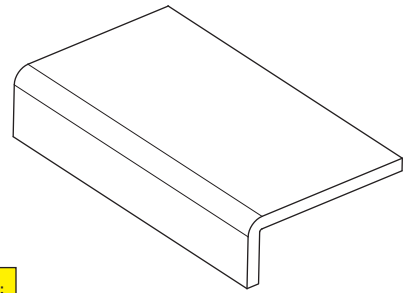

DOOR GASKET RETAINERS ARE AVAILABLE IN:
STEEL w/ HOT-DIP GALVANIZED FINISH
or STAINLESS STEEL (SELF-COLOR)

MODEL	SUB FOR	LENGTH	MATERIAL / FINISH	WEIGHT
MODEL 1404-6392	DGR-8HDG	8' / 2,438.4 MM	Steel / HDG	2.08 LBS / 0.94 Kg
MODEL 1404-6393	DGR-8SS	8' / 2,438.4 MM	Stainless Steel / Self-Color	2.08 LBS / 0.84 Kg
MODEL 1404-6394	DGR-9HDG	9' / 2,743.2 MM	Steel / HDG	2.34 LBS / 0.93 Kg
MODEL 1404-6395	DGR-9SS	9' / 2,743.2 MM	Stainless Steel / Self-Color	2.34 LBS / 0.93 Kg
MODEL 1404-6396	Narrow	9' / 2,743.2 MM	Stainless Steel / Self-Color	1.8 LBS / 0.82 Kg

MODEL 1404-6875-H

HORIZONTAL

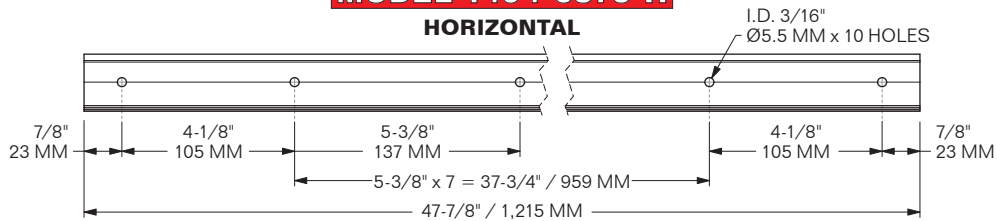

MODEL 1404-6875-V

VERTICAL

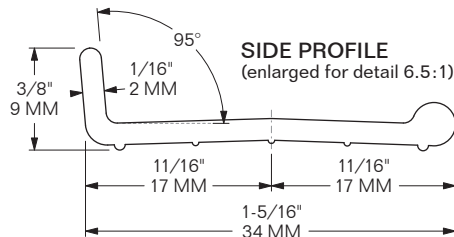
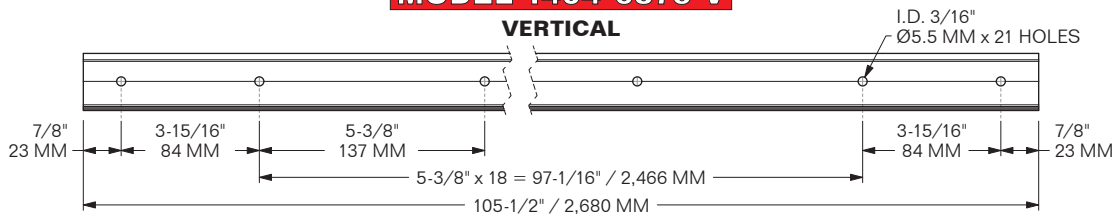

SUB FOR: JINDO R25700-0020 (Horizontal), JINDO R25700-1220 & R25700-2734 (Vertical)
FITS: 102" WIDE CONTAINERS
MATERIAL: ABS PLASTIC
1404-6875-H WEIGHT: 0.24 LBS / 0.11 Kg
1404-6875-V WEIGHT: 0.52 LBS / 0.24 Kg

MODEL 1404-8240-A

HORIZONTAL (for all Doors)

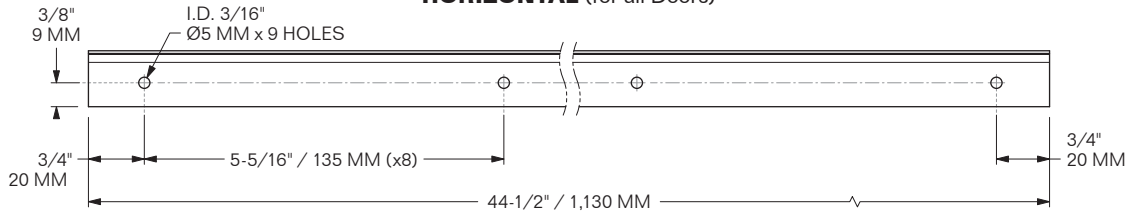

MODEL 1404-8240-B

VERTICAL (for 8' / Standard Cube Door)

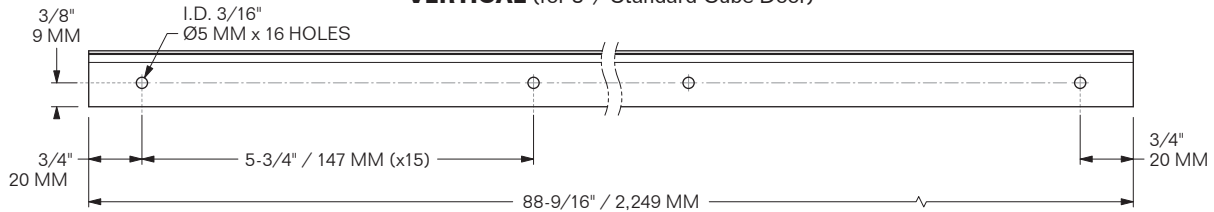

MODEL 1404-8240-C

VERTICAL (for 9' / High Cube Door)

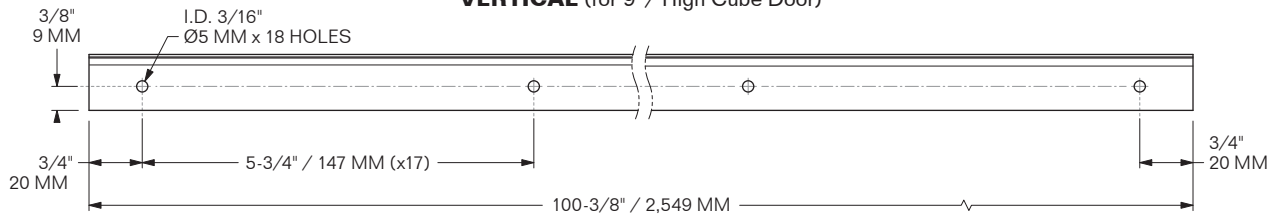

SIDE PROFILE (enlarged for detail, 6:1)

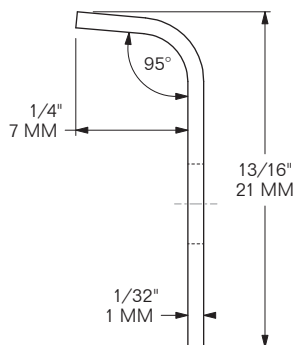

FITS: CIMC CONTAINERS
8240-A SUB FOR: CIMC D20-01A
8240-B SUB FOR: CIMC D20-01B
8240-C SUB FOR: CIMC D20-01C
MATERIAL: STAINLESS STEEL
FINISH: SELF-COLOR
8240-A WEIGHT: 0.51 LBS / 0.23 Kg
8240-B WEIGHT: 1.01 LBS / 0.46 Kg
8240-C WEIGHT: 1.15 LBS / 0.52 Kg